

**Zirkonzahn®**

*Human Zirconium Technology*



**PLANESYSTEM®**

*Function meets aesthetics*



## WHEN IT COMES TO HEALING ...

*... only the best is good enough. For this reason, we decided to work with my long-time colleague, Udo Plaster, MDT, in the realm of patient and model analysis.*

*His PlaneSystem® is a transfer method that respects and recognises the patient as a person. Whether we choose the digital or the traditional route in the preparation of dental restorations, the accurate recording of patient data by the PlaneSystem® will pave the way for the pursuit of complete health. Our company's software developers have integrated the PlaneSystem® into the Zirkonzahn CAD/CAM workflow. We have pledged our knowledge and our competence, as well as our organisational structures and international presence, in support of the PlaneSystem®.*



*So on the path towards a complete digital acquisition of the facial position on the articulator, Zirkonzahn, with its Face Hunter 3D facial scanner, developed in-house, and the PlaneSystem®, has taken two major hurdles and enjoys the infinite benefits that hard work and human effort can produce.*

*We encourage you to join us in aspiring to more, in being open to new developments and curious for new in-depth knowledge!*

*PlaneSystem® – developed by Udo Plaster MDT in cooperation with Zirkonzahn*

**ALA TRAGUS**

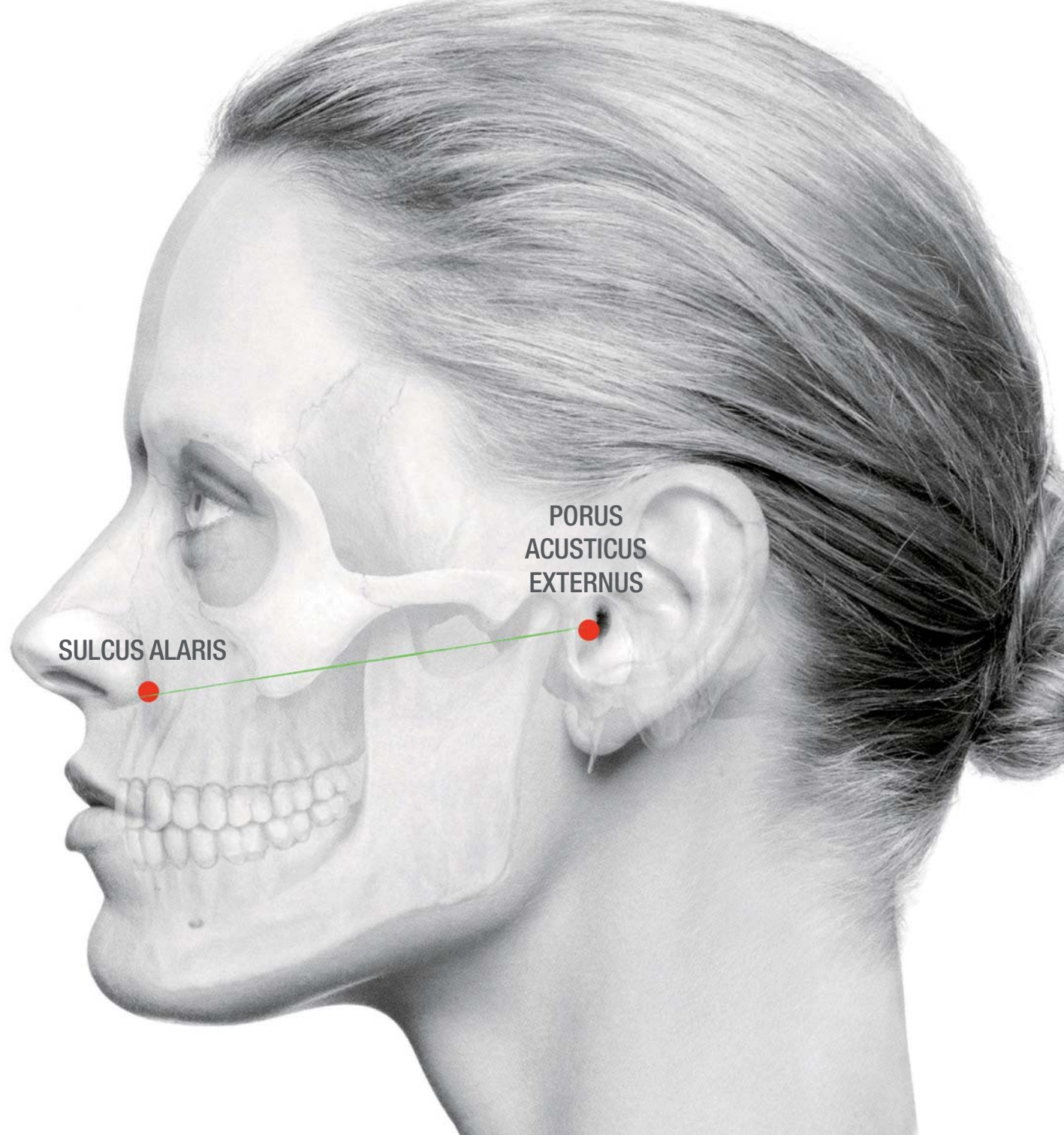

**SULCUS ALARIS**

**PORUS  
ACUSTICUS  
EXTERNUS**

# FUNCTION MEETS AESTHETICS

*Dental technicians need very precise data about each patient's individual situation to develop restorations in a virtual environment. The more precise the data, the better the achievable function and aesthetics of design (Fig. 1). In some situations, however, the technician will be unable to exploit the full potential of CAD planning software. This case may arise in the absence of information on how an available pair of casts relates to the rest of the body.*



Fig. 1: Ideal situation characterised by a 1:1 transfer of the maxillary position in the skull to the articulator and into the CAD software

## OCCLUSAL PLANE AND MIDLINE

*The precise position of the human maxilla, which forms an integral part of the skull, varies from individual to individual, depending on skeletal growth types, and the orientation of the occlusal plane is dictated by the growth pattern of the maxilla and mandible. For example, less growth of the mandible relative to the maxilla will normally involve an increasingly steeper orientation of the natural occlusal plane (Fig. 2). Differences in occlusal plane inclination may even be present*

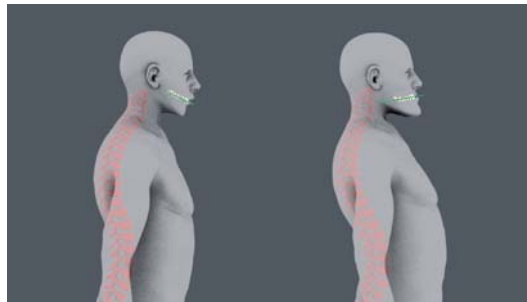

Fig. 2: Skeletal growth types with different orientations of the occlusal plane

*within an individual (due to natural bone volume asymmetries on both sides of the face) and can be verified based on the ala tragus line (Fig. 3). The absolute midline of the face is another suitable reference to identify natural asymmetries of the dental arch. This vertical line passes through the nasion (point between the eyebrows) and the sub-nasal point (point below the nasal tip). Normally, it will coincide with the skeletal midline that runs along the palatal suture. The dental midline, by contrast, will normally depart from the absolute midline by varying degrees to the left or right (Fig. 4). It is generally assumed that no human skull ever grows to ideal symmetry. The fact that the stomatognathic system is nevertheless capable of accomplishing its function results from the body's ability to offer some compensation for asymmetries through its muscles. Over time, this fundamental asymmetry can be compounded by additional asymmetries developing in the jaws because of tooth loss, reduced vertical dimension, changes in bite position, or orthodontic interventions. Any of*

these natural or induced asymmetries cause the organism to compensate, giving rise to asymmetric loads that may affect the whole body. Excessive loading may result in pain or damage to the body parts affected. Dental restorations may also be a cause of asymmetric loads inside the body. These may be avoided, however, if the clinician succeeds in identifying the position of the maxilla within the skull and determining how any asymmetries that may be present relate to this position. But what options are there available for the clinician to achieve this goal?



Fig. 3: The occlusal plane of this individual is differently inclined on both sides of the maxillary dental arch. The inclination of the occlusal plane coincides with the inclination of the ala tragus lines

## FACEBOWS AND TRANSFER BOWS

Conventional facebows and transfer bows have traditionally yielded good results in fabricating dental restorations. Experience tells us, however, that numerous try-ins and adjustments are normally required before a patient will be satisfied with the functional design of his or her dental restoration. This need arises from incomplete information about the maxilla, as familiar measuring techniques do not use reference points and reference planes suitable to record the position of the maxilla in the skull directly from the patient for subsequent transfer to the articulator. Yet data



Fig. 4: The midlines and the skeletal midlines form the absolute midline, The dental midline is not normally located along this line

about the position of the maxilla are essential to identify the patient's midline and occlusal plane for consideration in fabricating the dental restoration. The technician needs both of these parameters to appropriately position the dental reconstruction inside the jawbone, thus closely imitating the natural ideal situation and avoiding the development of asymmetric loads inside the body.

## THE PLANESYSTEM®

This system offers an alternative to conventional facebows in this regard. The name PlaneSystem® was selected to reflect the crucial role of the planes that the system identifies in the patient's skull, including the absolute midline, the zero-degree reference plane, and the individual occlusal plane (captured via the zero-degree reference plane). Also, the name refers not only to the measuring and transfer method per se, but also to the specifically developed equipment and the associated software by Zirkonzahn. The system comprises four elements: PlaneFinder® (Fig. 5), PlanePositioner® (Fig. 6), the PSI laboratory articulator (Fig. 7), and the CAD-PlaneTool PSI-3D (Fig. 8).



Fig. 5: PlaneFinder®



Fig. 6: The PlanePositioner® features a transparent plate used to position the maxillary cast inside the articulator and to individually reflect the natural occlusal plane



Fig. 7: PSI articulator



Fig. 8: CAD PlaneTool PSI-3D

Using the PlaneSystem®, it becomes possible to capture the position of the maxilla in the skull and the occlusal plane in almost any individual. This may include cases of dentate, edentulous or prosthetically restored maxillae, as well as situations characterised by loss of dental hard tissue, bite position, or single or multiple teeth. At the source of this process is one of the numerous amazing properties of the human body. All humans, when looking into a mirror, whether sitting down or standing on both legs in a stable position, will invariably, by engaging all natural aids (eyes, neck muscles, equilibrium organ), adjust their orientation such that the head posture

will intuitively be in balance with the body position and the sight axis parallel to the horizon.

This position is almost identically reproducible at all times, offering a stable frame of reference for the PlaneSystem® to record the position of each patient's maxilla in the skull and to measure his or her occlusal plane and related facial asymmetries. The same position is also known as Natural Head Position (NHP).

Recording the position of the maxilla and measuring the occlusal plane starts out by placing the PlaneFinder® on a level surface and aligning its upper arm horizontally. The extension of the arm thus provides a zero-degree reference plane, horizontally hemisecting the face at a zero-degree angle relative to the floor or base surface once the patient has placed his or her head in NHP (Fig. 9). That this zero-degree angle can be revisited any time – because the NHP is reproducible – renders the reference plane independent of any physical asymmetries.

## MEASURING AND RECORDING



Fig. 9: Patient adopting her Natural Head Position on the PlaneFinder®



Fig. 10: Recording of the position of the maxilla in the Natural Head Position



Fig. 11: The occlusal plane ...

*An independent reference value of this type could not be ensured by using a conventional facebow, which would involve application of a symmetrical measuring instrument to the asymmetric skull while there is no way for the articulator to reflect these asymmetries.*

*To record the position of the maxilla in the NHP, the maxilla is placed by the patient upon a bite tray connected to the PlaneFinder®, followed by indexing of this position with bite registration material (Fig. 10). The fact that the patient will always be able to return to this position in which the reference plane has been measured, guarantees the independent nature of this plane now recorded in a silicone index. The same applies to the inclination of the occlusal plane. Again, the zero-degree reference plane identified by the PlaneFinder® serves as an independent reference plane, which can be reproduced based on the patient's NHP at any time. The inclination angle is determined based on the ala tragus line, whose orientation may be assumed to be parallel to the natural occlusal plane (Figs. 11 and 12). This line extends from the lower border of the nasal wing (ala nasi) to the cartilage before the opening of the ear (tragus). As the bilateral values for this inclination may vary due to natural asymmetries,*



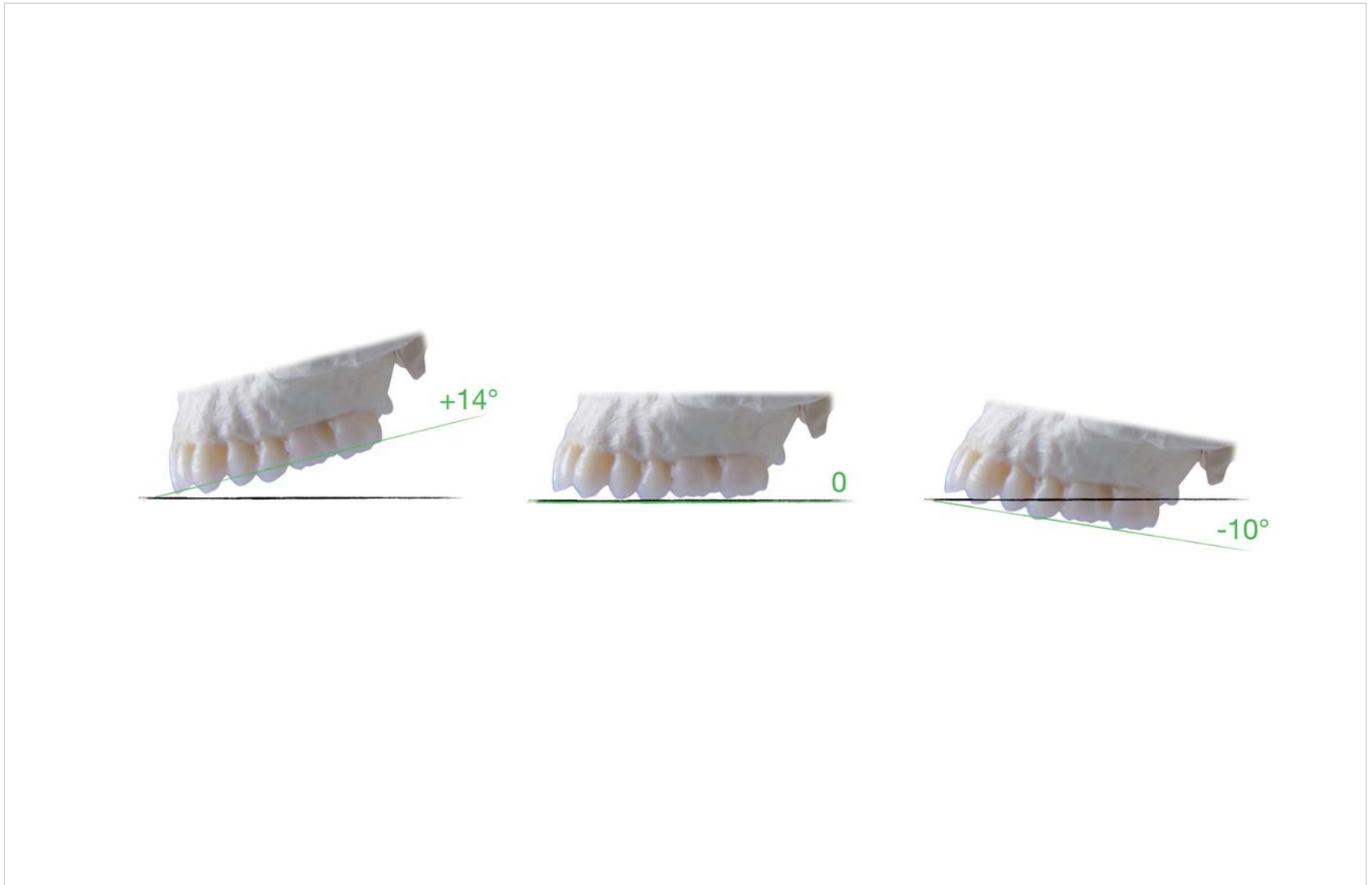

Fig. 12: ... may have an ascending, horizontal or descending inclination



Fig. 13: Aligning the maxillary cast orientation based on the silicone index

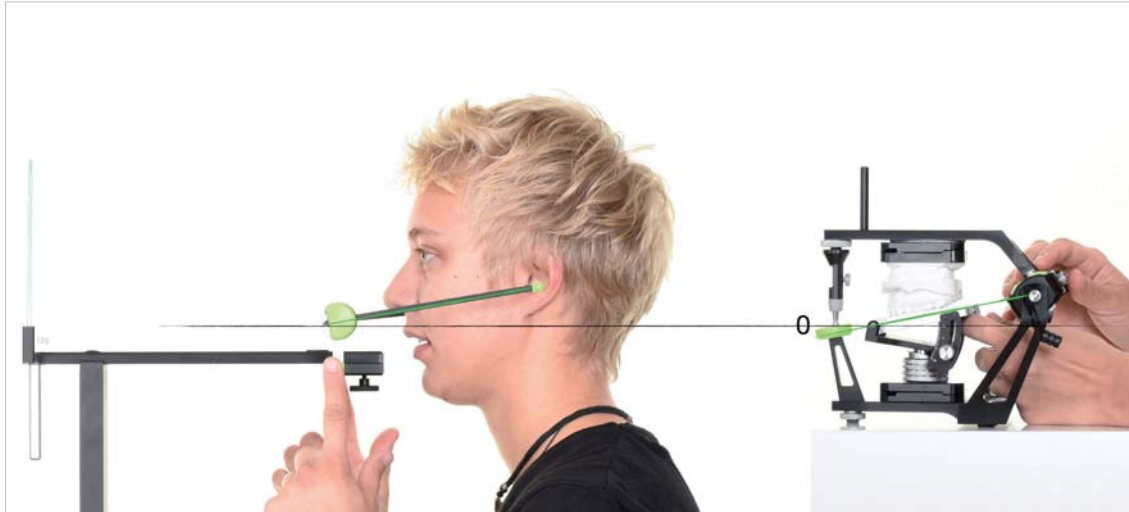

Fig. 14: Transferring the occlusal plane

*its angle is measured on both sides of the face.*

## TRANSFER TO THE ARTICULATOR

*The next step is to insert the maxillary cast into the silicone index, followed by placing the index onto the (horizontally oriented) PlanePositioner® and positioning inside the PSI articulator, effectively “copying” the situation recorded directly from the patient to the articulator (Fig. 13). After fixing the cast, the silicone index can be removed and the inclination of the occlusal plane can now be replicated by adjusting the PlanePositioner® inside the articulator to the angle values previously identified via the PlaneFinder® (Fig. 14).*

*From this point in developing the patient case, it will be possible to recheck the occlusal plane whenever the need arises on the PSI articulator. For example, Fig. 15 shows a mounted edentulous maxilla with a temporary restoration, which was repeatedly checked to see whether the occlusal plane designed at different points during the development of the case coincided with the natural occlusal plane that had been recorded directly from the patient.*



Fig. 15: Ideal setup for repeatedly checking the occlusal plane through different stages during the development of the case



Fig. 16: Scan of the mounted cast

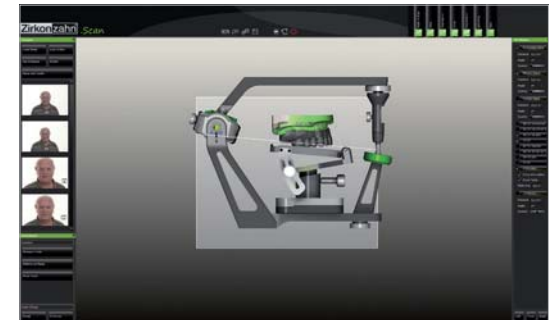

Fig. 18: The occlusal plane of this patient's existing dental restoration deviates markedly from his natural occlusal plane



Fig. 17: Virtual presentation of this specific patient's absolute midline

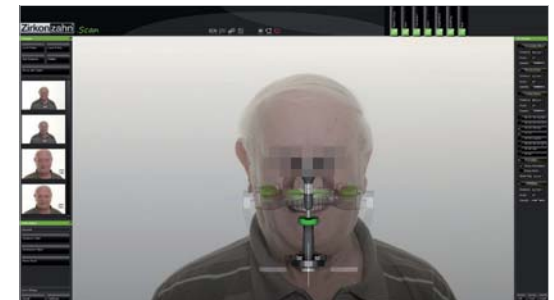

Fig. 19: For maximum realism during the design process ...

## POSSIBILITIES IN THE SOFTWARE

In the Zirkonzahn.Scan software environment, a project is created using the CAD-PlaneTool PSI-3D, followed by digitisation of the mounted cast with the Zirkonzahn S600 ARTI scanner (Fig. 16). Data which can be stored in this context include the patient's absolute midline (Fig. 17),

the occlusal plane (Fig. 18), tooth proportions as well as various 2D/3D photographic images (Face Hunter) and cephalograms (Figs. 19 and 20). For a well-founded aesthetic matching of the restorative tooth shapes and positions with the shape and gestures of the face, the patient should



Fig. 20: ... it is recommended to use 3D images obtained through the Face Hunter (Zirkonzahn)

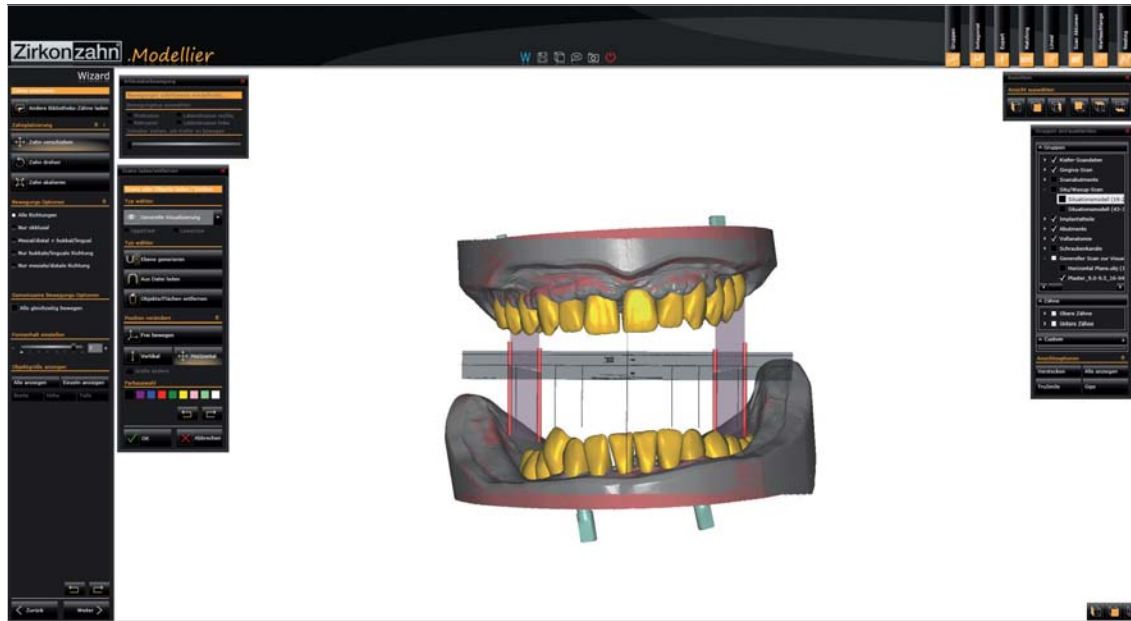

Fig. 21: The position of the occlusal plane (grey) and of the maxilla are recorded separately using the same reference plane, which permits to reproduce the current situation of the patient in the software

be depicted in those photographs from different angles and with varying facial expressions (like serious or laughing or smiling).

The next step is to open the project in the Zirkonzahn.Modellier environment. This will make more information (in addition to the photographs) available for the virtual design process, including the position and inclination of the natural occlusal plane in relation to the current position of the maxilla, whereby the

dental restoration can now be related to the natural occlusal plane also in the digital domain (Figs. 21 and 22), as well as the position of the absolute midline in relation to the current position of the maxilla, which may be used as reference for positioning the dental midline (e. g. in edentulous maxillae) to avoid asymmetric loads inside the body (Fig. 23). Starting from the absolute midline, the remaining tooth reconstructions are positioned in their correct proportions with the help of median values (Fig. 24).



Fig. 22: Positioning of the dental restoration based on the natural occlusal plane



Fig. 23: The position of the absolute midline and of the maxilla are recorded separately using the same reference plane, which permits to reproduce the current situation of the patient in the software



Fig. 24: Positioning of the remaining teeth, starting from the absolute midline, and designing the teeth in correct mutual proportions

## CONCLUSION

*Thanks to a fluid and smart workflow, all measurements, records and the articulation carried out by means of the PlaneSystem® can be used in further steps of the case realisation. The PlaneSystem®'s hardware and software elements used in this process are designed to include both function and aesthetics in the realisation of dental restorations.*

*While exact recording and measuring of each patient's situation will reduce the time for refinements needed to adjust the restoration to the individual requirements, this will not, of course, eliminate the need for direct try-ins in the patient's mouth to check his or her facial expressions (soft-tissue support), aesthetics, phonetics, and function.*

*Yet by taking into consideration the natural inclination of the occlusal plane on both sides of the dental arch, it should be possible to come very close to achieving the requirements that the dental restoration should meet in the patient's mouth even before the first try-in. Everybody involved can save valuable time in this way.*

*The occlusal plane of the restoration can be repeatedly checked, as needed, for agreement with the natural occlusal plane, both in the digital domain using the software and in the physical domain using the PSI articulator. This is a key benefit of the system, considering that even subsequent adjustments to restorations will not always succeed in compensating for a poorly simulated occlusal plane.*

*Udo Plaster/Marlies Strauß: Funktion trifft auf Ästhetik – im digitalen Workflow in: Digital Dental News, 2014 (8), p. 32-38 [modified version, February 2017]*

**FOR MORE INFORMATION ON THE  
PLANESYSTEM® COURSES:**

**WWW.ZIRKONZAHN.COM  
WWW.PLASTERDENTAL.DE**

## BIBLIOGRAPHY

*Ferrario VF/Sforza C/Serrao G/Ciusa V: A direct in vivo measurement of the three-dimensional orientation of the occlusal plane and of the sagittal discrepancy of the jaws. Clin Orthod Res 2000;3:15-22*

*Fonseca M/Plaster U/Strauß M: PlaneSystem®. Bestimmung der genauen Lage der Mitte und der individuellen Okklusionsebene im Verhältnis zur natürlichen Lage des Oberkiefers bei einem (zahnlosen) Implantatfall - Teil 2. In: Quintessenz Zahntech 2015;42(7):844-858.*

*Marquardt S/Moser A: Funktionelle ästhetische Rehabilitation: Die Übertragung der realen anatomischen Parameter des Patienten in den Artikulator. In: Quintessenz Zahntech 2014;40(11):1406-1416*

*Peng L/Cooke M: Fifteen-year reproducibility of natural head posture: A longitudinal study. In: AM J Orthod Dentofacial Orthop 116 (1) 1999: 82-85*

*Plaster U: Natürliche Asymmetrien und die patientenindividuelle Wiedergabe der Okklusionsebene ohne traditionellen Transferbogen. In: Quintessenz Zahntech 2013; 39(9):2-16*

*Plaster U: Das PlaneSystem® - vom analogen Gips- zum digitalen CAD-Modell. In: Quintessenz Zahntech 2014; 40(5):570-586*

*Plaster U/Strauß M: PlaneSystem®. Bestimmung der genauen Lage der Mitte und der individuellen Okklusionsebene im Verhältnis zur natürlichen Lage des Oberkiefers bei einem (zahnlosen) Implantatfall - Teil 1. In: Quintessenz Zahntech 2015;41(3):290-304*

*Plaster U/Hrezkuw S: Analog erfasst - digital referenziert. In: TeamWork J CONT DENT EDUC 1/2016;76-91*

*Plaster U: Surveying the Patient's Jaw. Specific static and dynamic values. In: Labline Spring 2016;61-70*

*Polz M: Zahnanatomie, Zahnfunktion und biomechanische Okklusion. In: Quintessenz Zahntech 2013;39(5):592-604*

*Sinobad D, Postic SD: Roentgenradiometric indicators of the position of the occlusal plane in natural and artificial dentitions. Eur J Prosthodont Restor Dent 1996;4:169-174*

*Xie J, Zaho Y, Chao Y, Luo W.: A cephalometric study on determining the orientation of occlusal plane. Hua Xi Yi Ke Da Xue Xue Bao 1993; 24:422-425*

# OCCLUSALLY SCREW-RETAINED PRETTAU® BRIDGES ON SIX MAXILLARY TITANIUM BASES AND FOUR MANDIBULAR IMPLANTS WITH A TITANIUM BAR

*The patient situation was scanned by Udo Plaster, MDT, using the PlaneSystem® and replicated in an articulator. The first trial set-ups were sent, along with the casts, to the Dental Laboratory Steger to be implemented and scanned. The try-ins were used as the diagnostic cast, and a titanium bar was designed as a reinforcement for the extended cantilevers in the mandible. The titanium bar was milled in the M1 milling unit, refined with a parallelometer and high gloss-polished. After re-scanning the bar, the superstructure was adjusted based on the new situation and modelled. The maxilla, too, was designed according to the situation and the occlusion was then tested against the mandibular situation. The work was then milled in Prettau® zirconia and finished. Cutbacks were made in the anterior region and in the gingival areas. The two Prettau® Bridges were coloured, dried and sintered in the Zirkonofen 700 Ultra-Vakuum. Then the restorations were re-fitted on the model, and the occlusion was adjusted by removing premature contacts. The cutback areas on the vestibular surfaces of the anterior teeth and the gingival area were veneered with ICE Zirkon Ceramics. The final characterisation was carried out by applying ICE Zirkon 3D Stains by Enrico Steger and glazing.*

*Dr. Manrique Fonseca under the guidance of Prof. Dr. Wael Att – University Medical Center Freiburg, Germany  
Udo Plaster, MDT – Plaster Dental-Technik GbR Nürnberg, Germany – Provisionalisation and articulator set-up  
Georg Walcher, MDT – Zirkonzahn Education Center Brunico, South Tyrol, Italy*



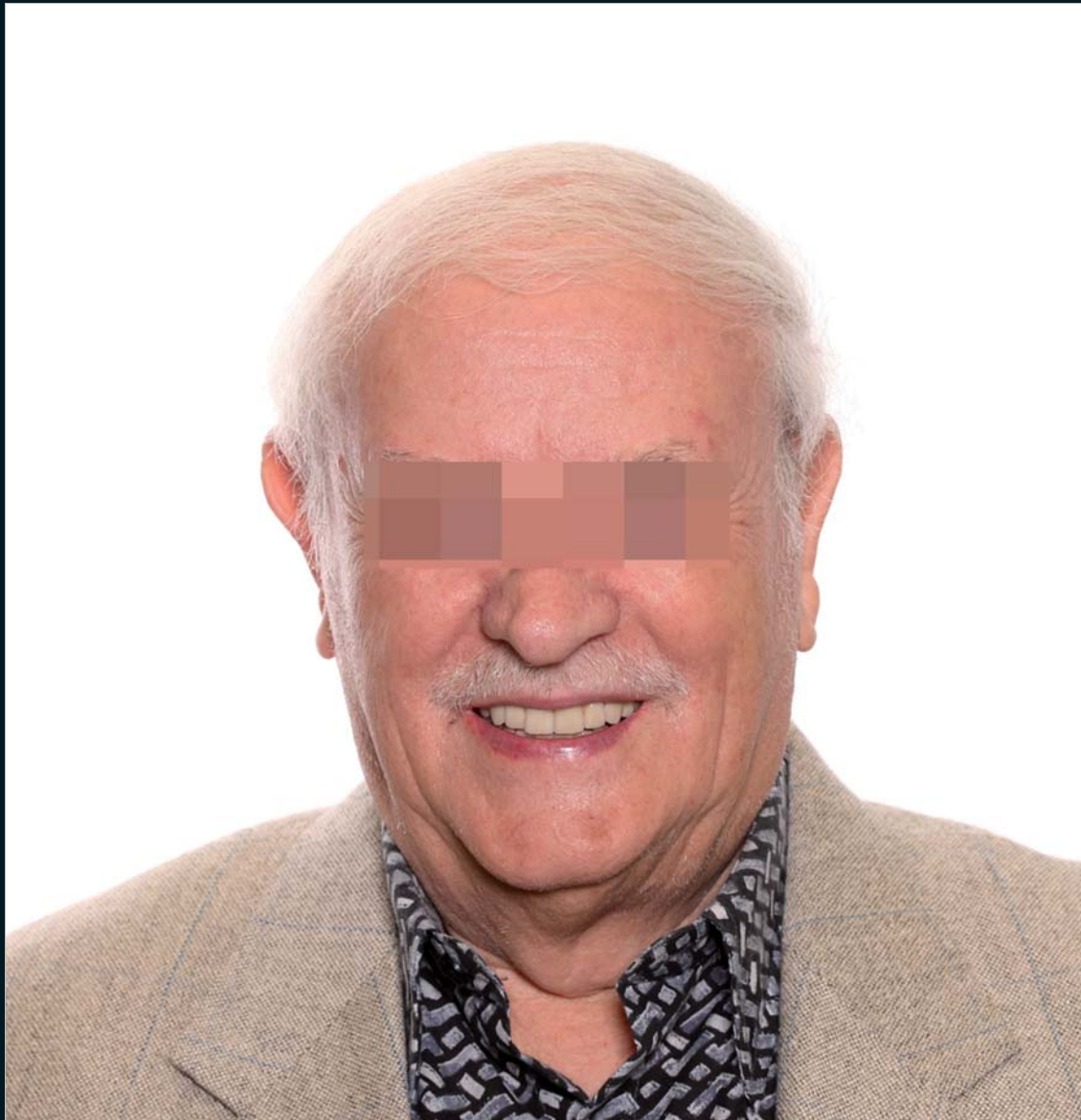

# COMPLETE MAXILLARY AND MANDIBULAR REHABILITATION USING PRETTAU® ZIRCONIA

*A patient case of edentulous maxilla and mandible, with 6 implants in the upper jaw and 4 in the lower jaw, was the basic situation of the described restoration. In the first phase of the treatment, we acquired the Natural Head Position (NHP) and all the necessary facial data through the PlaneSystem® and the Face Hunter and imported them into the software. Based on the digital data, we mounted the models in the virtual articulator and subsequently designed the restoration. We then produced provisional bridges made from resin. At this point, using the JawPositioner, we transferred the virtually articulated model of the maxilla 1:1 into the laboratory articulator. After two months of intraoral functioning, the provisional bridges were removed from patient's mouth, checked and scanned in order to incorporate any possible changes into the final zirconia reconstruction. Since no changes were applied, we directly modelled the final restoration. We chose Prettau® zirconia for the material because of its long-lasting durability and high aesthetic qualities. The two structures were milled in the M4 Wet Heavy Metal milling unit, coloured with Colour Liquid Prettau® Aquarell and sintered. We layered the structures with ceramic in the gingival area and on the vestibular sides of the anterior teeth, then we stained and glazed them. Once these steps were concluded, the final restoration was completed with titanium bases anodised in gingiva colour and then screwed into the patient's mouth.*

*Dr. Bjørn Gunnar Benjaminsen – Melhus Tannhelse, Melhus, Norway*

*Bjørn Borten, MDT – Art in Dent, Trondheim, Norway*

*Stein Aanerud, DT – Art in Dent, Kongsvinger, Norway*

*Antonio Corradini, MDT – Zirkonzahn Education Center Brunico, South Tyrol, Italy*







# PLANEFINDER®



# FACE HUNTER



**Face Hunter**

Scanner for the photo-realistic 3D digitalisation of faces as a working basis for the manufacture of individualised dental prostheses

Item number: SYAA0310



**Flash for Face Hunter**

Support for 2 flashes for the Face Hunter facial scanner

Item number: ZBAA4121



**Tripod for Face Hunter**

Support for the Face Hunter facial scanner, equipped with a shelf for the laptop, height adjustable

Item number: ZBAA4111



**Set Bite Tray Face Hunter**

5 supports for the positioning of the maxillary cast within the facial scans and 10 reference markers

Item number: ZBAC2151

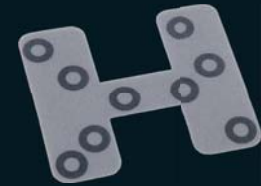

**Reference markers Bite Tray Face Hunter**

10 stickers for the detection of the Bite Tray Face Hunter's position

Item number: ZBAC1811



**Set Transfer Fork Face Hunter**

5 supports for the positioning of the maxillary cast within the facial scans and 10 reference markers

Item number: ZBAC2401



**Reference markers Transfer Fork Face Hunter**

10 stickers for the detection of the Transfer Fork Face Hunter's position

Item number: ZBAC2421



**Transfer Fork Reference Cover**

Transfer Fork attachment as position reference for the intraoral scanner

Item number: ZBAC2411



**Multi Marker Plate**

Positioning attachment for Easy Fix model holder for scanning the Transfer Fork Face Hunter in the Zirkonzahn scanner

Item number: ZBAC1931

# PS1 ARTICULATOR

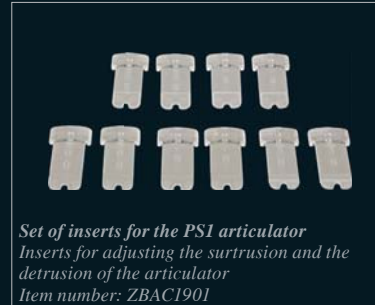

# PLANEPOSITIONER®



**PlanePositioner®**  
Platform used to position the maxillary cast in the PSI articulator and to reproduce the occlusal plane  
Item number: SYAA0370

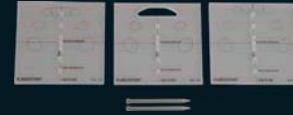

**Plaster Plates 5 mm**  
Plates used to set up the teeth on the PlanePositioner® (3 pieces)  
Item number: ZBAC2351



**Plaster Plates 5 mm splitted**  
Plates used to set up the teeth on the PlanePositioner® (6 pieces)  
Item number: ZBAC2361



**JawPositioner (46 pieces)**  
With the PlanePositioner®, it allows to transfer into the laboratory articulator the digitally articulated models (maxilla)  
Item number: ZBAC3501

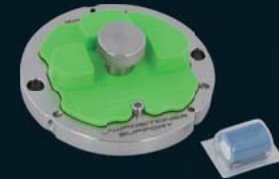

**JawPositioner Support**  
Support used to fix the JawPositioner into the orbit of the Zirkonzahn milling unit  
Item number: ZBAC3511

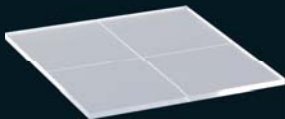

**Calibration Plate Plexi**  
For the centric alignment of the models in the PSI articulator with the PlanePositioner®, 2 mm

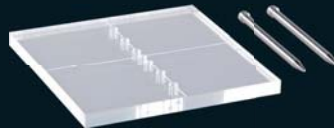

**Symmetry Measurement Plate**  
Symmetry measurement plate, 5 mm

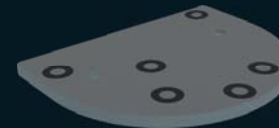

**Jaw Transfer Plate**  
For the transfer of the individual patient registration into the Zirkonzahn.Scan software (without face scans) with the Multi Marker Plate

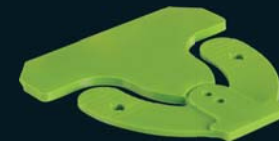

**Reference Transfer Plate**  
For the determination of the reference plane within the PlanePositioner®, in order to reference the maxilla in the Plane Analyser  
Item number: ZBAC1921

## PLANE ANALYSER

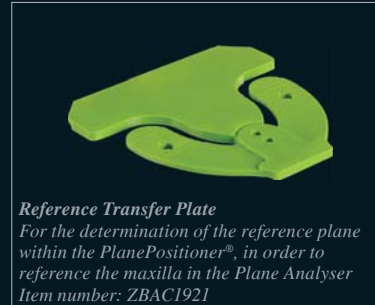
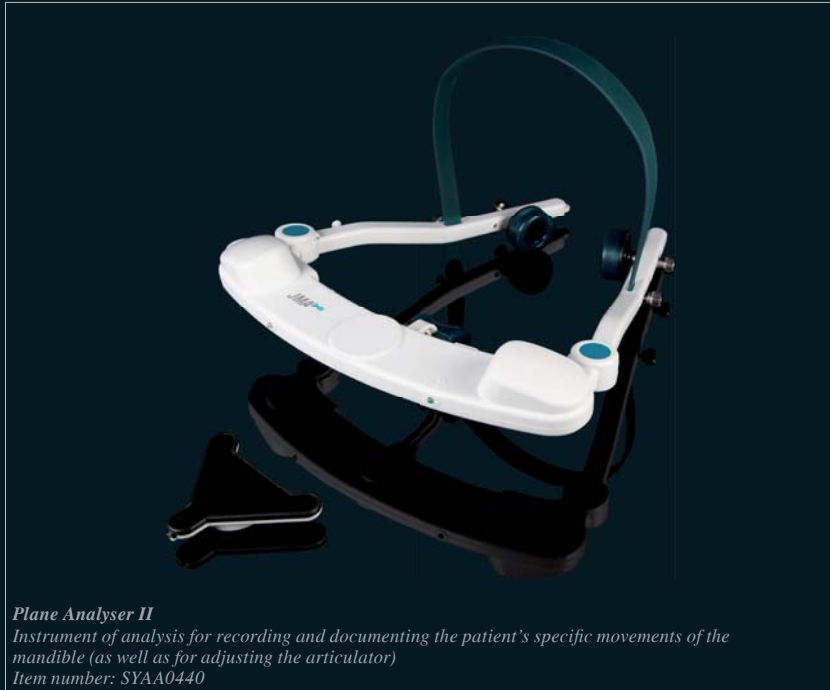



**Zirkonzahn®**

## PLANESYSTEM®

*Zirkonzahn Worldwide – Via An der Ahr 7 – 39030 Gais/South Tyrol  
T +39 0474 066 680 – F +39 0474 066 661 – [www.zirkonzahn.com](http://www.zirkonzahn.com) – [info@zirkonzahn.com](mailto:info@zirkonzahn.com)*

ENGLISH



WEAA2622=

*All information is subject to change. Errors and omissions excepted. Version: 05/07/2021*